

aeson

FLOORING SYSTEMS

Leading The Way In Sports & Fitness Flooring

2011-2012



FLOORING FOR ATHLETICS, SPORTS & FITNESS

800-523-0960 (Toll free in the U.S. & Canada) • 215-636-9000 • www.aesonflooring.com • info@aesonflooring.com

Table of Contents

HOW TO BUY A FLOOR

How to Buy a Floor3
 What I Need to Know4
 The Best Floor for How You Move5

FLOORING SURFACES

TS Collection6
 Sportstep Collection.....7
 Woodstep Collection8-9
 Compass Flooring System10-11
 Encore & Encore Elite.....12-13
 Hardwood Flooring System14-15

SUBFLOORS

Springstep IV16-17

MATS18

MSDS RATINGS19

SPECIALTY ITEMS20

FLOORCARE & MAINTENANCE

Flooring Installation/Troubleshooting20
 Flooring Supplies.....21
 Maintenance & Cleaning22

BEYOND MAINTENANCE23-25

SHIPPING & ORDERING INFORMATION.....26-27

A Message from the President



Our new 2011-2012 flooring kit is chock full of innovative products that will save you time and money. The following are just a few examples.

Just when you think it can't get any better along comes **Super TS**, a new flooring surface that transfers energy from the top surface to the bottom. Now you have a flooring that's both ideal for group classes and for light weights. The non-slip easy to clean surface makes **Super TS** a multi-use answer. (See page 6.) It's the toughest roll out flooring we have ever seen and it's exclusive with Aeson. Product improvements keep coming and we have the right here.

Environmentally friendly newly reformulated **Wipeout** handles the tough to get out stains and scuffs. (See page 22.)

On the wood flooring front, nothing beats **Compass**, our new portable basketball floor system. Save up to 75% off your labor cost when it comes to assemble, and breakdown. It goes together in all four directions at the same time without tools or hardware. DIN tested. (See pages 10-11.)

Did you know, your logo, customized school or company colors can be part of your flooring look? Check out our colorize finish. (See page 24.)

Aeson features a full line of flooring options, installation and maintenance product along with forty years of experience. On-line or on the phone Aeson is leading the way in health and fitness flooring.

Sincerely,

F. Randolph Swartz, President
 randy@aesonflooring.com • 800-523-0960 Ext. 105

P.S. Check out our new online store at www.aesonflooring.com
 All products inclusive of shipping and handling.

SOME OF OUR CUSTOMERS INCLUDE:

Gold's St Cloud, MN	Lake Placid Olympic Center Lake Placid, NY	Fitness Works for Women Toronto, ON
Town Sport International Philadelphia, PA	Champion Fitness Pontiac, IL	Longevity Fitness Club & Spa Vero Beach, FL
Tinker Airforce Base OK	Naval AirStation Puerto Rico	NBC Ft Worth, TX
USMC Leesville, LA	YMCA	West Chicago Parks Dist Chicago, IL
US 1 Fitness Miami, FL	Cammcore Fitness Nicolaville, KY	Escalade Sports Evansville, IN
	Fitness One Broomfield, CO	The Workout Company St Louis, MO

For a list of customers in your area, fax, e-mail or call with your zip code and product interest.

How to Buy a Floor

Where do I begin?

- List your needs
- Describe your space
- Define the circumstances of the space
- Clarify purchasing considerations

Most of you have little experience in determining what kind of flooring system is best for what you want to do. We at Aeson are here to help. To get you started, we have provided three lists of questions and one list to prioritize your purchasing considerations. Answer the questions, list your priorities and you are well on your way to selecting the best flooring system for you.

CONSIDER THE CIRCUMSTANCES BELOW

1. Renting or owning?
2. New construction or renovation?
3. Long term or short term use?
4. Portable, permanent, or semi-permanent? (*How long will the new floor be in the space?*)

DEFINE THE SPACE

1. What kind of floor or slab is currently in the space?
2. What is the slab/floor's current composition?
3. Where is the space (*basement, first floor*)?
4. What is the length and width of the space (*in feet or meters*)?
5. Are there any unusual structures in the space – columns, doors, jog in/outs, radiators, steps, windows, equipment?
6. What is the ceiling height?

FLOORING USE

1. What activities will take place on the floor?
2. Is the space under supervision while in use?
3. Will the space be occasionally used for other activities such as receptions?
4. Will equipment be used or placed on the floor?

OTHER FACTORS

1. Does the flooring system have a means of reducing vibration after impact?
2. Can the system be modified easily for special conditions (multi purpose/heavy equipment)?
3. Is the surface consistent?
4. How do I repair damaged areas without replacing the whole floor?
5. What type of maintenance is required?
6. Can I take the floor or flooring system with me if I move?

PURCHASING CONSIDERATIONS

- | | | | |
|----------------------------|------------------------|---|----------------------------|
| A. Price | E. Options | H. Appropriate Surface and Subfloor for Use | K. Non-Slip Characteristic |
| B. Guarantee | F. Maintenance Program | I. Appearance | L. Energy Absorption |
| C. Availability of Product | G. Product Support | J. Wear Characteristic | M. Financing |
| D. Company Expertise | | | N. Installation |

What Do I Need To Know?

- Absorption of energy
- Lateral foot support
- Resilient energy
- Other factors

WARNING

Any floor/floor system that you can squish together in your hands (feels soft) can be dangerous due to lack of lateral foot support.

ABSORPTION OF ENERGY

All movement activity generates energy. Energy directly returned to the body can result in shin splints, back and knee problems, fatigue, strains, and even broken bones. A non-energy absorbent floor or flooring system is dangerous. It can result in injury and law suits. Concrete is non-energy absorbent. Any substance put directly on concrete does not remove you from the concrete unless it contains air (like foam). Basket weave and foam sprung floating subfloors provide shock absorbent characteristics that eliminate the problems associated with hard, non-absorbent floors.

No floor can be the most absorbent and the most resilient at the same time. There is only so much energy and it can only be diffused in varying relationships of absorption and resilience. We call that “feel” and it affects performance. Different surfaces and subfloors have different “feels,” each appropriate for different activities.

LATERAL FOOT SUPPORT

Perhaps the most important and most overlooked attribute of a floor is lateral foot support. Without lateral foot support, you can not maintain balance. Today, the leading cause of injury is not shin splints but ankle injury, due in part to flooring systems that rely solely on absorbent materials or systems that are too spongy.

A term you may come across is **point elastic**, meaning deflection of the floor at the point of impact. The greater the deflection, the more unstable the floor.

RESILIENT ENERGY

In addition to absorbency, energy can be dissipated by resiliency—think of a diving board or trampoline. Energy transfers from the body to a subfloor that deflects and safely returns energy (spring). Wood is the best of the resilient materials.

Call us with your questions. We will have the answers and the numbers that go with them.

Non-slip

Safety is the number one issue when it comes to floors. The first safety concern is the non-slip characteristic of the surface. What to do?

Aerobic, step, and jazzercise need one kind of surface while people working with weights and machines need something entirely different. Multi-purpose, track, and ball sports have their own ideal characteristics.

Aeson has floors and subfloor systems ideal for each discipline.

Safety

The second safety concern has to do with the ability of the floor to absorb and dissipate energy, and/or safely return energy (resilient energy). If the floor fails to absorb or safely return energy, the body becomes the shock absorber, resulting in fatigue, pain, and injury. The nemesis of physical fitness is concrete or any other surface that is hard and unyielding.

All floor surfaces without foam underlayment provide no relief from a concrete slab. Check the flooring charts on page 5 for relative characteristics and the ideal combination for your movement activity.

The best floors for how you move

Primary Use

	FLOOR SURFACES	Aerobic/ Step	Weight Room	Jazzercise	Multi Purpose	Equipment Room	Ball Sport
I = Ideal	AESON FLEC ROLLS	X	I	X	C	I	X
E = Excellent	AESON INTERLOK	X	I	X	C	I	X
VG = Very Good	AESON MATS	X	I	X	C	I	X
G = Good	ENCORE/ENCORE ELITE	I	X	I	I	X	I
C = Conditional	HARDWOOD SPORT FLOOR SYSTEMS	I	X	I	E	X	I
X = Not Recommended	SPORTSTEP PLUS	E	C ³	E	I	E	I
1 = Dependent on subfloor.	SPORTSTEP ULTRA	E	C ³	E	I	E	I
2 = Requires a floating subfloor.	SUPER TS	I	C	I	I	G	G
3 = Light hand-weights only.	TS	I	C	I	I	G	G
	WOODSTEP	E ²	X	E ²	E ²	VG	C ¹
	WOODSTEP PLUS	E	C ³	E	I	E	I
	WOODSTEP ULTRA	E	C ³	E	I	E	I

Subfloors

- Springstep IV Complete Subfloor System for Studios and Home
- Easy to Install
- Multi-Purpose

FLOATING WOOD SUBFLOORS

Aeson offers floating wood subfloors (with customized variations) to absorb, dissipate and provide safe resilient energy return. (See pages 16-17.)

All floor surfaces without foam underlayment provide no relief from a hard concrete slab. Check the following flooring charts for relative characteristics and the ideal combination for your movement activity.

Springstep IV – Easy to assemble panels, no tools required. Assembles in 1/3 the time of a standard sprung floor. (pages 16-17).

FITNESS FLOORS WITH SELF-CONTAINED SUBFLOOR

Aeson offers rollout floors that have heavy-duty wear surfaces and high density foam underlayments. They can be installed directly over concrete have VG absorbency and have excellent performance characteristics. They are rated ideal for residual vibration and are excellent multi-purpose use flooring.

Woodstep Plus and **Woodstep Ultra** (pages 8-9) available in oak woodgrain pattern. **Encore** (pages 12-13), our hardwood flooring system, has a built-in floating wood subfloor.

Compass Flooring Systems™ (pages 10-11) integrates a new patent pending locking system that requires no tools and assembles in record time.

Performance & Characteristics

I = Ideal • E = Excellent • VG = Very Good • G = Good • C = Conditional • X = Not Recommended

FLOOR SURFACE	Aerobic/ Step	Yoga/ Pilates	Weight Room	Jazzercise	Multi- Purpose	Equipment Room	Ball Sport	Absorbency	Resiliency	Elimination of Residual Vibration
SPRINGSTEP IV, IV-B AND IV-C	E	E	X	I	I	X	C	E	E	E
SPRINGSTEP IV-A	E	I	X	E	I	X	E	I	VG	I
COMPASS FLOORING SYSTEM	E	E	X	I	I	X	C	E	E	E

Foam that gives easily under foot will not provide good lateral foot support. Balance can be lost and ankle injuries can result.

All Springstep subfloors provide ideal lateral foot support to keep you balanced.

Enhanced performance deals with sound amplification, jumping support, balance and residual vibration. The ability of a subfloor to absorb post impact vibration is important because keeping the floor still makes it easier to balance.

TS Collection



The ultimate multi-purpose floor ideally suited for all movement activity including aerobics, multi-purpose, gymnastics, and martial arts. Heavy duty portable and permanent flooring, which can be treated for differing degrees of non-slip.

- Heavy duty
- Multi-purpose
- Permanent or portable

CUSTOM COLORS (TS ONLY)
Full Rolls
6-10 weeks for delivery

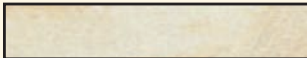

9240



9340

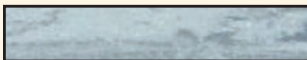

9200



9180

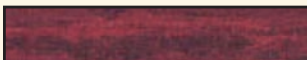

8580

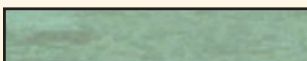

9080

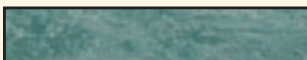

9220

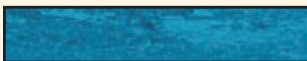

9040

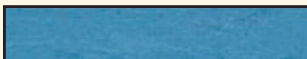

9170

Marbleized colors represented in this catalogue may not be an exact match to the actual flooring. Request sample if color match is critical.

	SUPER TS	TS
WIDTH	6.56' (2 lm)	6.56' (2 lm)
FULL ROLL LENGTH	65' (20 lm)*	65' (20 lm)*
THICKNESS	.09" (2.3 mm) homogeneous wear layer	.08" (2 mm) homogeneous wear layer
WEIGHT	5.5 lbs. per sq. yd. (2.98 kg per sq. meter)	5 lbs. per sq. yd. (2.71 kg per sq. meter)
PRICE	\$29. per sq. yd. (\$3.22 per sq. ft.) for custom cut lengths to the nearest foot	\$23. per sq. yd. (\$2.56 per sq. ft.) for custom cut lengths to the nearest foot
MATERIAL	<ul style="list-style-type: none"> • 100% virgin PVC • Fiberglass-lined • No factory finish 	<ul style="list-style-type: none"> • 100% virgin PVC • No Lamination • No factory finish
LIFE EXPECTANCY	• Up to 18 to 22 years	• Up to 18 years
GUARANTEE	• 7 years against wear	• 7 years against wear

20% DISCOUNT
on full rolls.

SUPER TS

STOCK COLORS

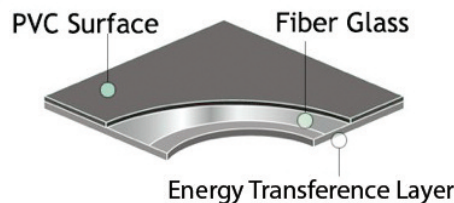

TS

STOCK COLORS

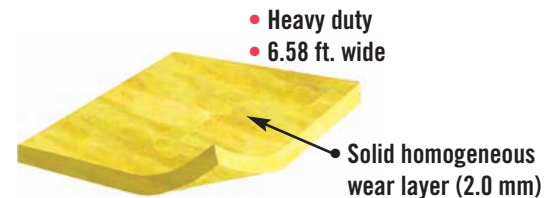

NOTE: Make sure the smooth surface is up and foam or textured surface is down when installing.

INSTALLATION

TS can be installed directly on a floating wood subfloor or hard wood surface, temporarily, semi-permanently, or permanently. It can be installed over wood flooring, using double-faced tape, adhesive, or ReUseIt (see page 21).

MAINTENANCE

Clean weekly, using a detergent/degreaser (Proclean - See page 22) that does not leave a residue. Heavy tap use may require a protective finish. For information regarding non-slip floor finish and cleaner, see page 23.

WARNINGS

- Do not use alcohol, ammonia, acetone, bleach, or solvents to clean surface. Consult with Aeson prior to using any product not recommended.
- Direct exposure to sunlight can cause reduced life expectancy due to UV radiation.

MSDS RATINGS: See page 19.

* Full roll lengths are subject to change.

Prices do not include shipping and handling. For shipping & handling quotes, please contact a Aeson representative.

Sportstep Plus • Sportstep Ultra

The feel and safety of a floating floor combined with easy, time-saving installation and maintenance. Lasts almost forever, yet can be moved at a moments notice. Four layer flooring provides wear surface guaranteed for seven years: fiberglass layer for stability, and high density foam underlayment layers to absorb shock. Great for everything: aerobics, step, jazzercise, workout equipment area, yoga, martial arts and multi-purpose activities.

- Resilient energy
- Absorbing energy
- For concrete subfloors
- Multi-purpose
- Portable, Semi-Permanent, or Permanent
- Absorbs sound
- Heavy duty

INSTALLATION

Installs loose lay for temporary use, with double-faced tape or ReUseIt (see page 21) for semi-permanent use and adhesive for permanent use. Installs directly over a concrete slab. (Slab should be sealed against moisture.)

MAINTENANCE

These acid and food stain resistant flooring systems need to be cleaned with a detergent/ degreaser (Proclean – see page 22) once a week. For information regarding non-slip floor finish, see page 23.

WARNINGS

- Do not use alcohol, ammonia, acetone, bleach or solvents to clean surface. Consult with Aeson prior to using any product not recommended.
- Direct exposure to sunlight can cause reduced life expectancy due to UV radiation.

MSDS RATINGS: See page 19.

* Full roll lengths are subject to change.

	SPORTSTEP PLUS	SPORTSTEP ULTRA
WIDTH	6.56' (2 lm)	6.56' (2 lm)
FULL ROLL LENGTH	57' (17.37 lm)*	49' (15 lm)*
THICKNESS	.26" (6.7 mm)	.31" (8 mm)
WEIGHT	7.7 lbs. per sq. yd. (4.18 kg per sq. meter)	8.5 lbs per sq. yd. (4.61 kg per sq. meter)
PRICE	\$56. per sq. yd. (\$6.22 per sq. ft.) for custom cut lengths to the nearest foot	\$65. per sq. yd. (\$7.22 per sq. ft.) for custom cut lengths to the nearest foot
MATERIAL	<ul style="list-style-type: none"> • Five layer PVC flooring • Clear PVC wear surface, photo engraved PVC layer, fiberglass lining, PVC layer, high density foam. 	
LIFE EXPECTANCY	• Up to 18 years	
GUARANTEE	• 7 years against wear	

20% DISCOUNT
on full rolls.

SPORTSTEP PLUS

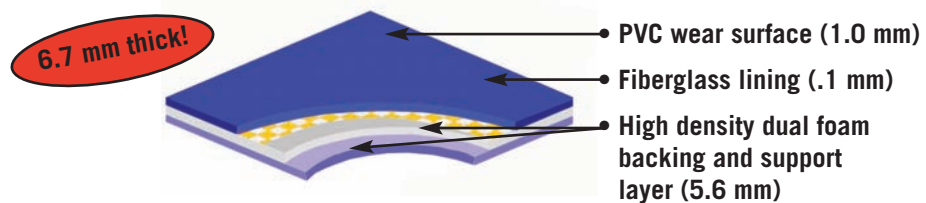

SPORTSTEP ULTRA

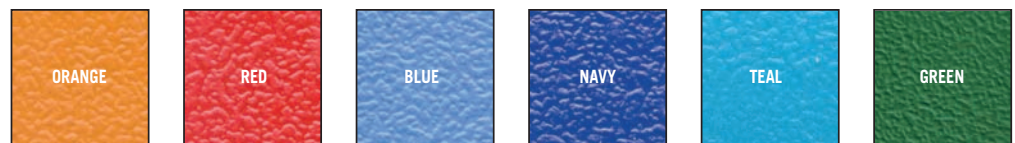
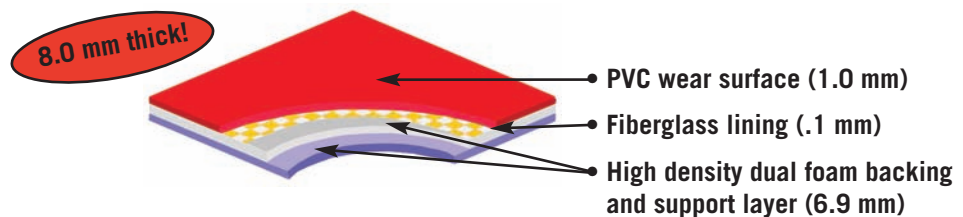

Prices do not include shipping and handling. For shipping & handling quotes, please contact a Aeson representative.

Woodstep Collection

Slightly textured, heavy duty surface. Exceptionally realistic wood design combines form and function. Resists wear and tear. Available in a variety of high density foam backings. Recommended for virtually all aerobic activity including jazzercise, martial arts and step.

- Heavy duty
- It really looks and feels like wood without the high maintenance expense
- Excellent for professional and home use

WOODSTEP



WOODSTEP PLUS & WOODSTEP ULTRA



WOODSTEP

2.0 mm thick!

Installs on floating wood subfloor.

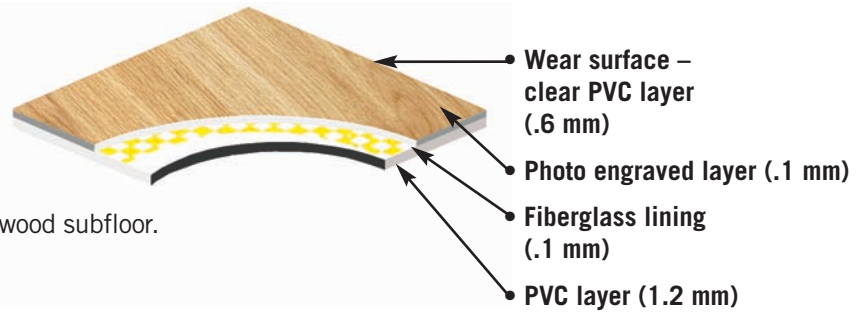

WOODSTEP PLUS

6.7 mm thick!

Installs directly on slab.

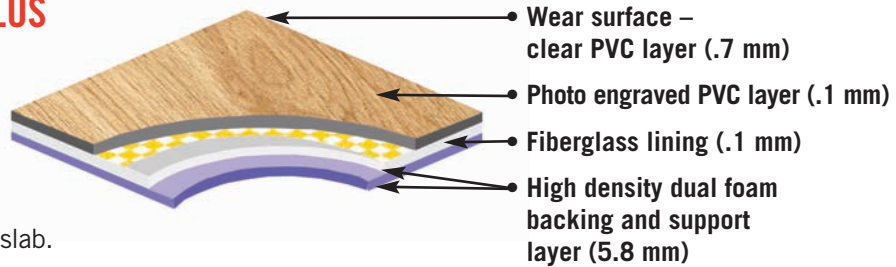

WOODSTEP ULTRA

8.0 mm thick!

Installs directly on slab.

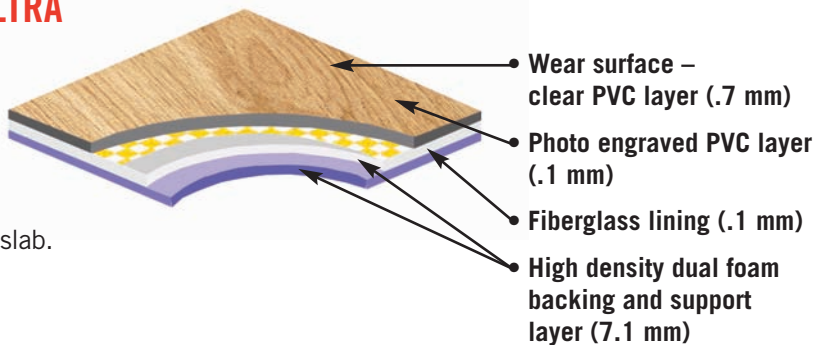

Woodstep Collection

	WOODSTEP	WOODSTEP PLUS	WOODSTEP ULTRA
WIDTH	6.56' (2 lm)	6.56' (2 lm)	6.56' (2 lm)
FULL ROLL LENGTH	65' (20 lm)*	57' (17.4 lm)*	49' (15 lm)*
THICKNESS	.08" (2 mm)	.264" (6.7 mm)	.33" (8 mm)
WEIGHT	6.5 lbs. per sq. yd. (3.53 kg per sq. meter)	7.7 lbs. per sq. yd. (4.18 kg per sq. meter)	8.5 lbs per sq. yd. (4.61 kg per sq. meter)
PRICE	 \$38. per sq. yd. (\$4.22 per sq. ft.) for custom cut lengths to the nearest foot	\$56. per sq. yd. (\$6.22 per sq. ft.) for custom cut lengths to the nearest foot	\$65. per sq. yd. (\$7.22 per sq. ft.) for custom cut lengths to the nearest foot
MATERIAL	High tech four layer floor <ul style="list-style-type: none"> • Wear surface – clear PVC layer • Photo engraved PVC layer • Fiberglass net layer • PVC layer 	Five layer PVC flooring <ul style="list-style-type: none"> • Clear PVC wear surface, photo engraved PVC layer, fiberglass lining, PVC layer, high density foam 	Five layer PVC flooring <ul style="list-style-type: none"> • Clear PVC wear surface, photo engraved PVC layer, fiberglass lining, PVC layer, high density foam
LIFE EXPECTANCY	• Up to 18 years	• Up to 18 years	• Up to 18 years
GUARANTEE	• 7 years against wear	• 7 years against wear	• 7 years against wear

INSTALLATION

Woodstep can be installed directly on a floating wood subfloor or hard wood surface, temporarily, semi-permanently, or permanently. It can be installed over wood flooring using double-faced tape, adhesive or ReUseIt (see page 21).

Woodstep Plus/Ultra installs loose lay for temporary use, with double-faced tape or ReUseIt (see page 21) for semi-permanent use and adhesive for permanent use. Installs directly over a concrete slab. (Slab should be sealed against moisture.)

MAINTENANCE

These acid and food stain resistant flooring systems need to be cleaned with a detergent/degreaser (Proclean - see page 22) once a week. For information regarding non-slip floor finish and cleaner, see page 23.

WARNINGS

- Do not use alcohol, ammonia, acetone, bleach or solvents to clean surface. Consult with Aeson prior to using any product not recommended.
- Direct exposure to sunlight can cause reduced life expectancy due to UV radiation.

MSDS RATINGS: See page 19.

* Full roll lengths are subject to change.

Prices do not include shipping and handling. For shipping & handling quotes, please contact a Aeson representative.



THE COMPASS FLOORING SYSTEM™

Introducing the Aeson Compass Flooring System™. The first floor system that assembles in all directions, cutting installation time by more than 50%! Tools, screws, cables, dowels, and adhesive are obsolete. The Aeson Compass Flooring System™ is a permanent floor that is completely transportable. The CFS features Aeson's all new patent-pending Posi-Force™ locking system. Simply slide the pieces into place and the floor does the rest, joining the panels beside it with near seamless results. To disassemble simply reverse the procedure.

The Compass Flooring System™ is available in multiple configurations including a basic subfloor system, and a version that can be pre-fitted with nearly any surface including solid hardwood, roll out vinyl, engineered surfaces, and much more. The fully sprung adaptable shock layer allows for custom fabrication to fit any need from acting to aerobics, theater to tap.

Please call to design your ideal Compass Flooring System™.

Have a custom need? All panels can be cut to fit your exact need on site with a standard circular saw.

- Easy assembly and disassembly
- No tools, screws, cables, dowels, or adhesive needed
- Reduces labor costs and set up time by at least 50%

THE COMPASS FLOORING SYSTEM™

WIDTH	48"
LENGTH	96" and 48" panels available
THICKNESS	Variable depending on surface and suspension chosen. Base height = 2.25"
WEIGHT	Variable depending on surface and suspension chosen.
PRICE	Starting from \$10. per sq. ft.



CONSTRUCTION

SURFACE

Variable: Sanded Face Plywood, Engineered Hardwood, 3/4" Hardwood, Colored and Finished Surface, Vinyl, or your Custom Requested Surface

SUSPENSION LAYER

Rubber or Closed Cell Foam: .5" to .75"

BASE LAYER

.75" Engineered Specialty Plywood

SUPPORT LAYER

.75" Engineered Specialty Plywood

Call Aeson for price quote on your custom Compass Flooring System™.

Prices do not include shipping and handling. For shipping & handling quotes, please contact a Aeson representative.



THE COMPASS FLOORING SYSTEM™

MULTI-PURPOSE VINYL SYSTEM

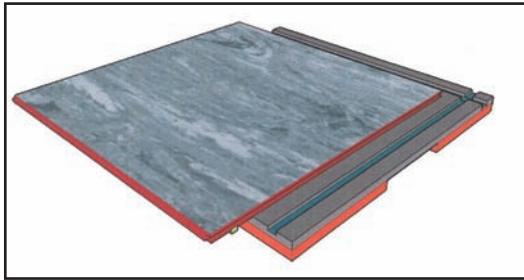

Surface layer: Roll Out Vinyl

HARDWOOD SYSTEM

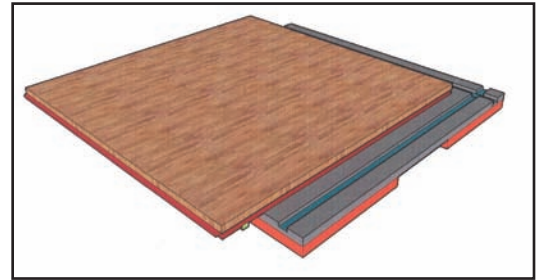

Surface layer: 3/4" Hardwood

SURFACE LAYER: Variable

 **RED:** 3/4" Plywood Support Layer

 **GREY:** 3/4" Base Plywood Layer

 **BLUE:** Self Contained Lock System

 **ORANGE:** Suspension Layer

The panels come in three sizes which allow for a near ideal fit.

- 96" x 48" (243.8 cm x 121.9 cm)
- 48" x 48" (121.9 cm x 121.9 cm)

For Installation and Maintenance information, please contact a Aeson representative.

Encore Collection



Exceptional real hardwood design combines form and function. Encore is the revolutionary “click and go” transportable hardwood floor with a factory finish and an integrated sprung subfloor. Recommended for virtually all activities including basketball, volleyball, aerobics, martial arts and impact sensitive activities.. Encore Elite uses Beech and Maple hardwoods for a harder, more durable surface. Custom foam options are available to provide additional shock absorption.

- No adhesive, screws, or nails needed for install
- No sanding (required at installation) or finishing
- Installs directly over concrete slab with vapor barrier
- Transitional edging available
- Transportable

ENCORE



ENCORE ELITE



	ENCORE	ENCORE ELITE
PANEL WIDTH	7.38" (187.45 mm)	7.38" (187.45 mm)
PANEL LENGTH	44.25" (1.12 lm)*	44.25" (1.12 lm)*
THICKNESS	1.32" (33 mm)	1.32" (33 mm)
WEIGHT	5.0 lbs/panel (2.27 kg/panel)	5.0 lbs/panel (2.27 kg/panel)
PRICE (1 PANEL = 2.28 SQ. FT./212 LM)	\$10. per sq. ft. \$22.80 per panel	\$11. per sq. ft. \$25.08 per panel
STORAGE	<ul style="list-style-type: none"> • Wood panels should be stored flat on a skid of equal or greater dimension in a climate controlled environment. 	
LIFE EXPECTANCY	<ul style="list-style-type: none"> • Up to 10-15 years 	
GUARANTEE	<ul style="list-style-type: none"> • 7 years against wear 	

Encore can be configured to any size room or space. An Aeson representative will be happy to quote an Encore floor that meets your exact specifications.

ENCORE/ENCORE ELITE

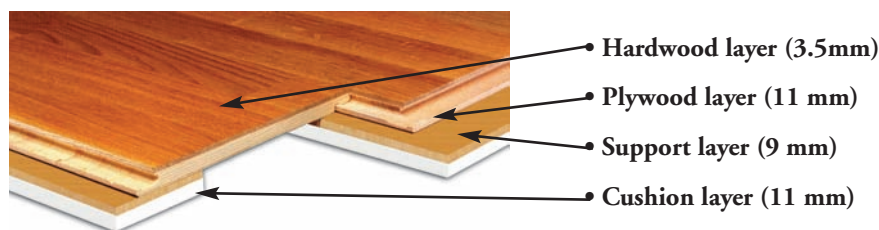

Prices do not include shipping and handling. For shipping & handling quotes, please contact a Aeson representative.



Encore • Encore Elite

INSTALLATION

Encore can be installed over virtually any firm level surface. Installation can be permanent, semi-permanent, or short term.

MAINTENANCE

Encore's natural hardwood surface is resistant to most common staining including food. However regular floor maintenance is recommended using Proclean on a weekly basis. (See page 22.)

Encore can be screened or if need be sanded and refinished. It is a real hardwood flooring system and subject to damage like any other hardwood surface.

- Real hardwood
- Do-it-yourself installation
- Pre-finished
- Seamless appearance
- No metal
- Pick it up and take it with you

STORAGE CARTS
 4' long x 3' wide x 3' high Call for pricing.
 Holds 425 panels (969 sq. ft.)

MSDS RATINGS

DIN RATING: 18032.2	VERTICAL DEFORMATION: 3.2 MM (MIN 2.3 MM)	FORCE REDUCTION: 63 % (MIN 50 %)	BEHAVIOR UNDER A ROLLING LOAD: PASS	SLIDING PROPERTIES: 0.4 (0.4 - 0.6)
-------------------------------	--	---	---	---

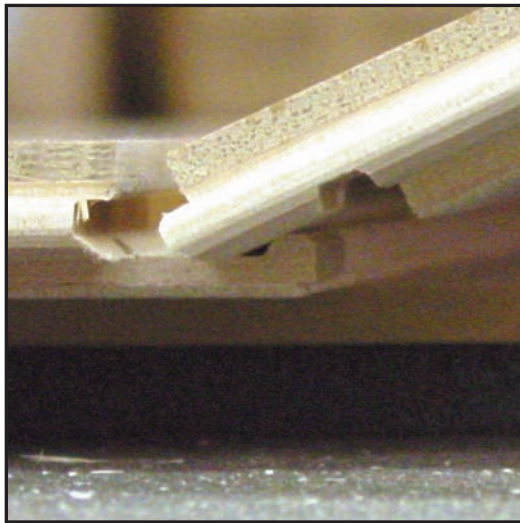

PATENTED TONGUE & GROOVE SYSTEM

Hardwood Flooring System



Custom-made permanent finished hardwood sports flooring system with pre-fabricated subfloor for easy installation. Exceeding DIN 18032 pt2 and EN standards. Can be used for all sports and athletic activities.

BASKETBALL

Professional grade basketball flooring that exceeds the highest DIN, EN and FIBA standards for quality and performance.

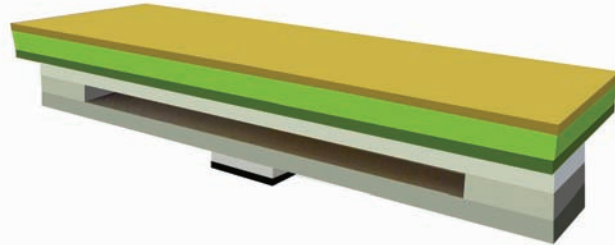

- 6mm Hardwood Layer
- 12mm Plywood Layer
- 6mm Cross Laminated Birch Ply Layer
- 18mm Cross Laminated Birch Ply Spring Layer
- 12mm Cross Laminated Birch Ply Spring Layer
- 5mm Elastic Rubber Shock Pads

MULTI-PURPOSE

The perfect flooring for aerobics and multi-purpose athletic activities.

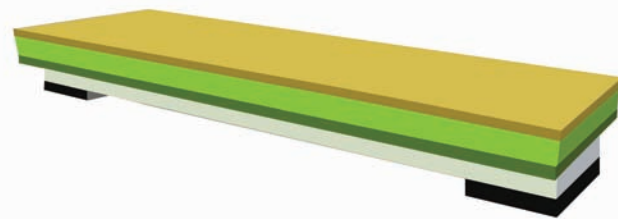

- 6mm Hardwood Layer
- 12mm Plywood Layer
- 6mm Cross Laminated Birch Ply Layer
- 18mm Cross Laminated Birch Ply Spring Layer
- 5mm Elastic Rubber Shock Pads

- Superior energy absorption and resilience
- Custom made to your specifications
- Exceeds DIN, EN and FIBA Standards

Lifetime guarantee when installed by certified Aeson Installer and maintained with Aeson products.

One year material defect warranty when self-installed. Contact Aeson for additional information.



Hardwood Flooring System

HARDWOOD FLOORING SYSTEMS

SPECIFICATIONS	Professional hardwood floor with state-of-the-art subfloor system. Available in many pre-finished species, including oak, maple, ash and others. For additional specifications, see illustration on previous page.
PRICE (depends on size, configuration and style)	Approximately \$10. per sq. ft. (material only)
FINISH	• Pre-finished for sport
LIFE EXPECTANCY	• 20 years
GUARANTEE	• Lifetime guarantee when installed by certified Aeson Installer and maintained with Aeson products. • One year material defect warranty when self-installed. Contact Aeson for additional information.

* Prices vary as to size and configuration of space.

INSTALLATION

Should be professionally installed. Contact Aeson for details.

MAINTENANCE

Dry mop daily. Wet mop with Proclean or Proclean NS (See page 22). See www.aesonflooring.com for complete details. Lifetime guarantee when installed by certified Aeson Installer and maintained with Aeson products.

MSDS RATINGS: See page 19.



Prices do not include shipping and handling. For shipping & handling quotes, please contact a Aeson representative.

Springstep IV

The professional standard for floating wood resilient permanent and semi-permanent subfloors over concrete slabs and other hard surfaces. Resilient and energy absorbent. Safety and performance at a great price.

Specifications and materials vary by country.



- Choice of five systems for any movement activity
- Recyclable
- Safe
- Cost effective
- Improves performance
- Eco-friendly

SPRINGSTEP IV

The easy subfloor. The nominal 2' x 2' pre-fabricated Random Wafer Board panels, with patented tongue and groove connection system, rest on "L" shaped high density foam suspension forms. Springstep IV offers excellent energy absorption and resilience. Panels are sealed for water resistance. Its tongue and groove system allows for easy assembly.

The lightweight, 6.5 lb panels can be installed in hours instead of days. No screws. No staples. No nails. No patching. No sanding. It is 1/4 the work with no tools required.*

Easy to disassemble, move to a new location, and re-install.

* Circular saw may be needed for custom fit.

SPRINGSTEP IV-A: Suitable for yoga and other non-impact activities. Highly energy absorbent.

Springstep IV-B: Suitable for high-impact activities. Very resilient.

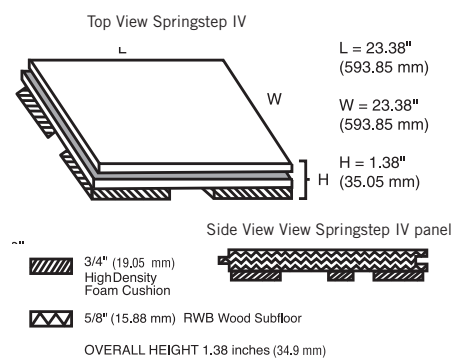

	WOOD PANEL SIZE	UNDERLAYMENT	PRICE UNASSEMBLED	PRICE PRE-ASSEMBLED
SPRINGSTEP IV	23.38" x 23.38" x 5/8" (593.85 mm x 593.85 mm x 15.88 mm) wood panels	3/4" (19.05 mm) thick "L" shaped foam forms	\$12. per panel	\$13. per panel
SPRINGSTEP IV-A	23.38" x 23.38" x 5/8" (593.85 mm x 593.85 mm x 15.88 mm) wood panels	1/2" (12.70 mm) foam sheeting	\$12. per panel	Not Available
SPRINGSTEP IV-B	23.38" x 23.38" x 5/8" (593.85 mm x 593.85 mm x 15.88 mm) wood panels	2" x 2" x 2" (50.80 mm x 50.80 mm x 50.80 mm) foam cubes	\$12. per panel	Not Available
SPRINGSTEP IV-C	23.38" x 23.38" x 5/8" (593.85 mm x 93.85 mm x 15.88 mm) wood panels	3" x 3" x 3/4" foam blocks (peel & stick)	\$12. per panel	\$13. per panel

- Do-it-yourself in hours instead of days
- Transportable
- Includes the wood and shock absorption layer
- No hardware, screws, patching, or sanding
- Snap together patented tongue and groove construction

For detailed installation instructions, visit: www.aesonflooring.com.

Prices do not include shipping and handling. For shipping & handling quotes, please contact a Aeson representative.

Springstep IV

INDIVIDUAL COMPONENTS

- 23.38" x 23.38" x 5/8" (593.85 mm x 593.85 mm x 15.88 mm) Springstep IV wood panels without foam\$7. panel
- 3/4" (19.05 mm) thick "L" shaped foam formsnot sold separately
- 1/2" (12.70 mm) foam sheeting (5' wide by your custom length).....\$1.50 sq. ft.
- 2" x 2" x 2" (50.80 mm x 50.80 mm x 50.80 mm) foam cubes\$.50 each
- 2" x 2" x 2" (50.80 mm x 50.80 mm x 50.80 mm) peel & stick foam cubes\$.60 each
- 3" x 3" x 3/4" (thick) peel & stick foam blocks\$.40 each

* Minimum order 500 cubes/blocks for free shipping. Continental USA Only.

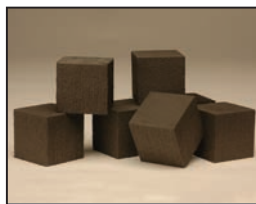

2" x 2" x 2"
Foam Cube

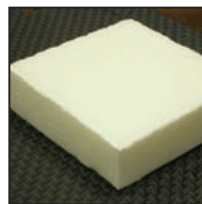

3" x 3" x 3/4"
Foam Block

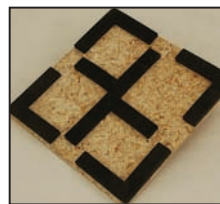

Springstep IV
L-Shape Foam Layout

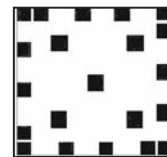

Springstep IV
Foam Cube Layout
2" x 2" x 2"
(21 required)

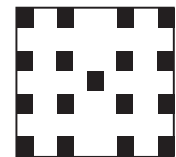

Springstep IV
Foam Block Layout
3" x 3" x 3/4"
(17 required)



TRANSITION PIECES (Ramps)

These new lightweight, poly-resin transition pieces are fully portable and easy to install. They can be placed and relocated without the use of permanent fasteners. The black, non-marring, anti-slip ramp is ADA compliant. With its all-new construction, these transition pieces can be easily trimmed to fit virtually any space with simple hand tools yet strong enough to support more than 1,000 pounds.

Standard Configuration:

36" wide x 15" high x 8" slope
Custom sizing available.

Price: \$60.

Springstep IV pricing does not include shipping and handling. Pricing for all other products on this page do include shipping and handling.

Prices do not include shipping and handling. For shipping & handling quotes, please contact a Aeson representative.

Rubber Mats



Rubber flooring offers superior durability and can be used both indoors and outdoors. Aeson rubber products are ideal for areas that need protection from free weights, heavy loads, spikes, exercise machines and more. This environmentally friendly recycled rubber meets the requirements of Executive Order 13101, and is available in solid black and colored accent (flecs) as shown below. Available in rolls, mats, and interlock from 3/8" to 3/4" allows for limitless versatility. Simple cleaning is done by broom, damp mop, or vacuum.

AESON INTERLOK



Precision cut 100% recycled puzzle piece rubber mats create a near seamless appearance when installed. These large tiles are small enough to self install but large enough to not require adhesive. Available in corners, edges, and centers from 3/8" to 3/4" in solid black and color flec.

- 4' x 4' (1.23 lm x 1.23 lm) (45" x 45" inside edge to edge)
- 15 year warranty
- Beveled and transition edges available

Call for Pricing

AESON MATS



Solid durable 4' x 6' 100% recycled rubber mats provide floor protection from equipment damage, reduce excessive noise, and comes with a textured surface to provide additional slip resistance in the workout area even when wet. Available in 1/2" and 3/4" solid black and colored flecs.

- Textured non-skid surface
- Easy and economical to install
- Requires no cementing
- Won't mark floors
- Allows equipment to sit level & firm
- Will not creep

Call for Pricing

AESON FLEC ROLLS

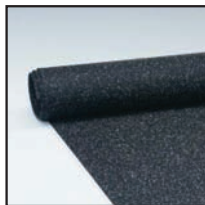

5 foot wide 100% recycled rolled rubber provides extreme durability when used with weight machines and exercise equipment. Provides fewer seams for a more aesthetically pleasing look. Also, an ideal surface for making walkway areas spike and slip resistant. Available in 3/8" thick material in solid black and colored flec.

- **WIDTH:** 48" (1.23 lm)
- **THICKNESS:** 3/8" (9.53 mm)
- **LENGTH:** 25', 50' or 75' only (7.62 lm, 15.24 lm, or 22.86 lm)
- **WEIGHT:** 2 lbs per sq. ft. (.0929 sq. meters)

- **PRICE: BLACK** Call 800-523-0960 for pricing.

COLOR FLEC Call 800-523-0960 for pricing. (Color percentage: 10%, 15%, 20%).

- Also available in sheets of 4' x 6' (1.23 lm x 1.83 lm) and 4' x 8' (1.23 lm x 2.44 lm) in both 1/2" and 3/4" (12.70 mm and 19.05 mm) thickness. These mats can be used as single sheets for area protection or as an entire flooring system.

Call for Pricing

Aeson Flec Rolls, Interlok and Mats Colors available in stock:



BLACK



WHITE

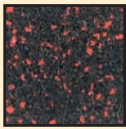

RED

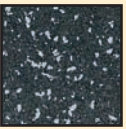

GREY

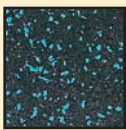

BLUE

Aeson Interlok & Aeson Mat

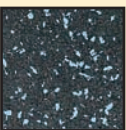

SKY BLUE

Aeson Flec Rolls

Material Safety Data Specifications Ratings

MATERIAL SAFETY DATA SHEETS								
Product	Wear Thickness	Layer	Foam Cushioning	Backing/ Stability Layer	Static Load	Sound Reduction (db)	Fire Ratings	Fire Ratings
HARDWOOD FLOORING SYSTEMS	SEE DIAGRAM - PAGES 14-15			N/A	N/A	N/A	N/A	N/A
SPORTSTEP ULTRA	.04" (1.0 mm)	N/A	.27" (6.9 mm)	.004" (.1 mm)	N/A	N/A	NF P 92-512 LM3	EN-13501-1 (Cf1-S1)
SPORTSTEP PLUS	.04" (1.0 mm)	N/A	.18" (5.3 mm)	.004" (.1 mm)	100 lbs./sq. in.	59	NF P 92-512 LM3	EN-13501-1 (Cf1-S1)
SUPER TS	.09" (2.3 mm)	.5 mm	1.7 mm	.1 mm	100 lbs./sq. in.	N/A	NF P 92-512 EN 13501-1LM3 Cfl - S1 ONORM B 3810 & ONORM B 3800/1 / DIN 4102	N/A
TS	.080" (2 mm)	.080" (2 mm)	N/A	None	125 lbs./sq. in.	6	EN ISO 9239-1 28kw/m2 EN ISO 11925-2 PASS	ASTM E648 - Class 1
WOODSTEP	.02" (.6 mm)	.05" (1.3 mm)	N/A	.004" (.1 mm)	125 lbs./sq. in.	6	EN-13501-1 (Bf1-S1)	N/A
WOODSTEP PLUS	.03" (.7 mm)	.004" (.1 mm)	.23" (5.8 mm)	.004" (.1 mm)	100 lbs./sq. in.	59	NF P 92-512 LM3	EN-13501-1 (Cf1-S1)
WOODSTEP ULTRA	.03" (.7 mm)	.004" (.1 mm)	.28" (7.1 mm)	.004" (.1 mm)	N/A	N/A	NF P 92-512 LM3	EN-13501-1 (Cf1-S1)

RUBBER BLOCK INTERLOCKING SPECIFICATIONS												
PRODUCT	Material	Size	Thickness	Color	Weight	Surface	Origin	Hardness	Flame Spread	Compression	Tensile Strength	Coefficient of Friction
AESON FLEC ROLLS	100% Recycled Rubber	4'x25', 50', or 75'	3/8"	Black	4.0 lbs/sq. ft. (3/8" thick)	Flat one side, Wire Mesh Texture/ Anti-skid Surface on the other.	Manufactured in the USA	60 Shore A Nominal	Less than .50" Minute (Avg. 3/4")	36% @ 50 psi	320 psi	Dry: .096 Wet: .089
AESON INTERLOK	100% Recycled Rubber	Standard 30"x30" Edge, Corner or Center <i>Custom Sizes also Available.</i>	3/4" or 1/2"	Megalock: Black Flecstep: Color Percentages of 10%, 15% or 20% Colors include: Pearl, red, green, and blue	4.0 lbs/sq. ft. (3/4" thick) 3.0 lbs/sq. ft. (1/2" thick)	Flat one side, Wire Mesh Texture/ Anti-skid Surface on the other.	Manufactured in the USA	60 Shore A Nominal	Less than .50" Minute (Avg. 3/4")	36% @ 50 psi	320 psi	Dry: .096 Wet: .089
AESON MATS	100% Recycled Rubber	Standard 4'x6'	3/4" or 1/2"	Black or Flec Colors 10%, 15% or 20% Pearl, red, green, and blue	4.0 lbs/sq. ft. (3/4" thick) 3.0 lbs/sq. ft. (1/2" thick)	Flat one side, Wire Mesh Texture/ Anti-skid Surface on the other.	Manufactured in the USA	60 Shore A Nominal	Less than .50" Minute (Avg. 3/4")	36% @ 50 psi	320 psi	Dry: .096 Wet: .089

Specialty Items

WALL-MOUNTED ADJUSTABLE STRETCHING BARRE



Aircraft-grade aluminum with scratch-resistant, black acrylic coating for added comfort. Includes wall unit and one barre.

6' (1.83 lm) section single barre\$110.
6' (1.83 lm) section double barre\$195.

WALL-MOUNTED MIRRORS

Lightweight, glassless*, non-distortion mirror is more reflective than glass and is non-fogging. Wall-mounted mirrors are easy to install with accompanying double face tape and mounting brackets.

4' x 6' (1.23 lm x 1.83 lm)\$375.
4' x 8' (1.23 lm x 2.44 lm)\$400.

* Mylar stretched and vacuum sealed over aluminum frame. 1" thick.

SOY YOGA MAT



Perfectly cushioned with a light-tack, non-slip surface that is ideal for all yoga styles. The lightweight, durable mat balances the right amount of padding with a slim design. Made from all natural soy, the yoga mat is latex free and easy to maintain.

Simply hand wash with mild soap and dry flat. Includes its own storage bag.

24" wide by 72" long and 1/5" thick.....\$29.99

Floor Installation/Troubleshooting

FLOOR PREPARATION

DO:

- Wash floor 2-3 times with lukewarm water before using.
- For special non-slip requirements or treatments see page 23 or call our technical support.

DO NOT:

- Use alcohol, ammonia, acetone, bleach or solvents to clean surface.

LONG TERM SEMI-PERMANENT INSTALLATION

REUSE IT

Do-it-yourself installation instructions are included with every order and are available online at www.aesonflooring.com.

Floor Installation/Troubleshooting

PERMANENT INSTALLATION

Professional installation recommended. Complete instructions are included with each container of Aeson adhesive. Seams should be double cut by a professional. Chemical welding is not recommended. Heat welding is not necessary. Aeson carries heat welding rod material in all colors if you wish a seamless floor.* If you have any questions, call us at 800-523-0960 or email info@aesonflooring.com.

AESON is not responsible for costs related to the delay, damage or installation of its flooring.

*Seamless does not mean invisible. Heat welding prevents moisture from penetrating the seam and destroying the adhesive.

Aeson Flooring offers an Installation Booklet available both online at www.aesonflooring.com and at 800-523-0960.

TEMPERATURE

Variations in temperature can have a negative impact on installation, non-slip characteristics and how fast the floor gets dirty. Warm air holds moisture; cool air releases moisture. During the day most facilities become warmer due to body heat. At night, the temperature drops due to no bodies, plus the thermostat is usually turned down. In the morning, the moisture held by the warm air has settled on the floor along with all the dust and dirt that had been stirred up during the day. The combination of these two factors create slippery floors which are prone to develop scuff marks.

CONTRIBUTING PROBLEMS

Doorways that open directly to the outside invite dust, pollen, and contaminants into your workspace.

Note: Most floors need weekly cleaning with a detergent/degreaser. (Proclean - see this page.)

The best way to pick up scuff and dye marks is to use a floor machine with brushes.

Aeson offers Slip NoMor Finish that protects the floor, keeps it non-slip and makes it easier to clean (see page 23).

HANDLING & STORING YOUR FLOOR

Store in a dry, clean, protected space. Temperature should be between 55 and 80 degrees. Floors should be wrapped around a rigid tube with a diameter of at least 4 inches (6 inches is better). Floors should be stored on end.

All prices include shipping & handling in the Continental U.S.A. For shipping outside of the Continental U.S.A., please contact an Aeson representative.

Flooring Supplies

NEW!

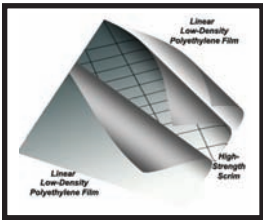

INSTALLATION AESON VAPOR BARRIER *Versa Shield*

Excellent sheet vapor barrier applications with extra reinforcement scrim. Laminated in between the polyethylene layers. Specifications: 4' x100' (400ft²/roll) 8mil. **\$122.**



VAPOR BARRIERS (LIQUID) *Bone Dry*

BONE DRY is a penetrating, permanent, waterproofing concrete sealer. Designed for long term sealing of concrete prior to installing Aeson flooring products. It is easy to apply. With over 30 years of use without call backs or job down time. Bone Dry is the ultimate water vapor solution. **5 gallon bucket / (850ft² to 900ft² per bucket) \$260./bucket**

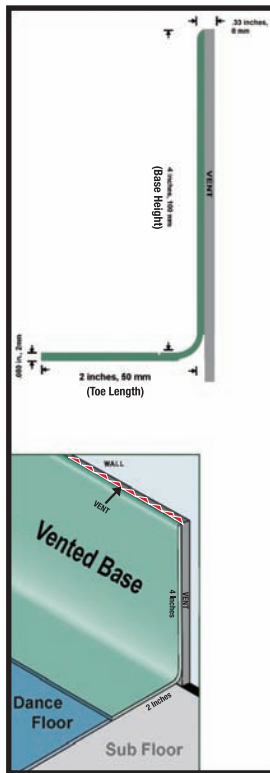

FLOORING SYSTEM ACCESSORIES VENTED WALL BASE

Aeson's unique vented wall base can be installed before or after the floor surface. The special backing material allows the area below the subfloor to constantly ventilate. The vinyl base material can also be heat welded to the dance floor surface if desired. Ventilated floor systems maintain the floor's dimensional stability, and help reduce any possible moisture build up below the subfloor. Sold in 78 3/4" long sections. Each section is 4" high with a 2" toe. Available in four colors: white, tan, black and grey. **\$28./each (\$4.27 per running foot)**

Adhesives

SEMI-PERMANENT INSTALLATION

- **RELEASE DOUBLE-FACED TAPE**
2" x 36 yds. (50.80 mm x 32.92 lm)
Used in conjunction with top seam tape. Anchors all types. **\$21./roll; \$400./case of 24 rolls (SAVE 20%)**

PERMANENT INSTALLATION

- **AESON VINYL ADHESIVE**
One gallon covers 15 sq. yds. (13 sq. meters)
4 gallon pail \$140.
- **WELDING ROD 300 ft. (91.44 lm) TS only \$70.**

FOR PROFESSIONAL INSTALLATION

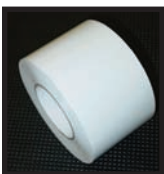

4" SEAM TAPE
Professional 4" wide double sided cloth adhesive tape for use in large floor installation and in difficult ReUselt applications. Professional installation is recommended when using this product. Specifications: 4" wide x 108' **Price: \$33.** See ReUselt on page 21.



CAUTION: All slabs must be covered with a vapor barrier. (See page 21.) Use 10-12 mils plastic sheeting or liquid sealer. CAUTION: All tape has latex in the adhesive. All installation materials do not include shipping costs. For detailed installation instructions, visit: www.aesonflooring.com

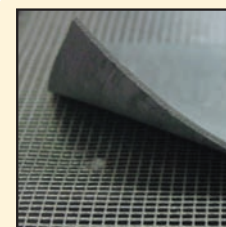

REUSEIT SYSTEM

Now you can install virtually any floor surface over any existing sub-floor without messy adhesives, or having to hire expensive flooring contractors.

The ReUselt system gives you all the benefits of a permanent installation with the ease of a semi-permanent installation without the use of top tape or the hassle of resetting your floor every two years. Yet when you need to remove the floor you simply roll it up and take it away. Simply purchase new supply of ReUselt and install at your new location. Used ReUselt can be removed from the sub-floor and thrown away. You can install it yourself and it's goof proof.

Just follow the easy directions that come with each roll!

- Full rolls only
- 1 meter x 25 lm (3.25' x 82.5')
- \$180
- \$.68 per sq. ft.

Caution: Exposure to extreme or variable heat conditions can cause failure. Contact Aeson at 800-523-0960 with questions. Do not apply over luan or any underlayment containing an oil-based finish. Consult with your Aeson representative for compatibility issues.

All prices include shipping & handling in the Continental U.S.A. For shipping outside of the Continental U.S.A., please contact an Aeson representative.

Maintenance Information

- Dry mop your floor every morning before classes.
- Use a small dehumidifier and turn it on at night to eliminate excessive moisture in the air that could contribute to a slippery floor.
- Temperature changes can also cause flooring to expand and contract causing ripples and possible separation from double faced tape (used in semipermanent installations).
- If temperature fluctuations are great and cannot be controlled install flooring with top tape only and reset the flooring as needed.
- Check your HVAC system and check air quality

Do not use cola, ammonia, bleach, alcohol, solvents or any product that says it will leave your floor shiny.

Aeson Flooring's Maintenance Booklet is available free of charge or may be downloaded from our web site at www.aesonflooring.com. Questions call 800-523-0960.

NEVER!

- expose to direct sunlight
- store lying down
- store on top of each other
- store in excess cold or heat
- fold or crease
- turn over by twisting and overlapping from the side edges
- put weight on that is rolled up
- install loose laid (without tape or adhesive)
- expose to standing water

WINTER NOTIFICATION: Slip NoMor products shipped between December 15th - March 15th require a \$10. surcharge for heat packaging.

SAVE TIME & MONEY

Invest in the proper finish and maintenance program.

Maintenance & Cleaning



FLOOR FINISH APPLICATORS

Aeson floor finish applicator for use with Aeson Slip NoMor Finish System. Applicator Kit includes 2 applicator covers. In certain situations more than one applicator kit

may be necessary, please consult a sales representative prior to ordering. **\$7.50 each**



SLIP NOMOR 2000C

Concentrated formula.

A non-slip solution that adds a slip-resistant surface to all floor surfaces, including wood, tile, vinyl, and linoleum. Will not damage any surface. You control the degree of non-slip simply by adding water. One gallon makes approx. 14-20 gallons.

1 gallon - \$50.

Case of 4 gallons - \$180. / 5 gallon pail - \$200.



PROCLEAN

Superconcentrate industrial strength floor cleaner that will not harm your floor or floor finish. Three ounces cleans 1,000 square feet! 5 gallon container holds 224 applications—just 33 cents an application. Use on a regular basis (at least once a week) to keep your floor looking clean and hygienic.

5 gallon - \$75. / 1 gallon - \$25.

One gallon will clean a 1,000 sq. ft. floor for a year.



PROCLEAN NS

Keep your floors clean, hygienic, and non-slip with Proclean NS. This super-concentrate industrial strength floor cleaner with slip resistance formula should be used on a regular basis (at least once a week) and will not harm your floor or floor finish. The Proclean NS will clean 1,000 sq. ft. for two months with weekly cleanings.

5 Liter bottle (1.32 gallon) - \$45.

Case of four (4) 5-liter bottles - \$140. / 5 Gallon - \$135.



WIPEOUT

Newly improved grime removing formula in a convenient pump spray bottle

The new eco-friendly, easy to use Wipeout is ideal for removing dye and scuff marks. Its improved formula penetrates, loosens, breaks down and dissolves many unwanted stains from all vinyl and non-porous surfaces. Not effective on aluminum compound tap residue.

6.8 oz. bottle.....\$21.95

Buy three bottles and the fourth bottle is free.

If you experience any problem with a Aeson product, you must notify Aeson within 72 hours of receipt to validate, exchange, credit, or file insurance claim.

All prices include shipping & handling in the Continental U.S.A. For shipping outside of the Continental U.S.A., please contact an Aeson representative.

Beyond Maintenance

- 1/4 the maintenance time
- Maintains slip resistance
- Makes clean up easier
- Extends the life of your floors
- Works on virtually any surface

CAUTION: SENSITIVE TO COLD WEATHER

All Slip NoMor products are sensitive to cold. Store at room temperature to prevent failure.

*Slip NoMor Finish has a shelf life of 9 months.

WINTER NOTIFICATION:

Slip NoMor products shipped between December 15th - March 15th require a \$10. surcharge for heat packaging.

* In extreme wear situations, it is recommended to re-apply every year.

- Floor renovation without replacing your floor
- A floor finish that can turn any surface into a safety floor
- A floor finish that can change the color, design, and look of your existing floor
- A floor finish that gives you the option of a matte, satin, or high gloss look
- A floor finish that lasts up to two years and requires no waxing, buffing, or burnishing
- A floor finish that requires no tools beyond the applicator we provide
- A floor finish that is environmentally friendly
- A floor finish that cuts maintenance in half, and keep delivering a non-slip coefficient of friction even in the presence of water

The Slip NoMor line of finishes delivers all the above, guaranteed, or your money back.

SLIP NOMOR MAINTENANCE SYSTEM

Slip NoMor Finish:*

Save time and money with our durable, eco-friendly, matte surface finish with a high level of slip resistance suitable for studios and all performance surfaces. With the Slip NoMor Maintenance System, only two coats are required. No more burnishing, buffing, or periodic stripping.



FOR VINYL SURFACES:

Kits include:

- Cleaner/Stripper
- Finish
- Weekly Slip NoMor Cleaner
- Applicator: 2 covers

SIZES/PRICES**:

- 500 sq. ft. - \$325.
- 1,000 sq. ft. - \$528.
- 1,500 sq. ft. - \$760.
- 2,000 sq. ft. - \$1,000.

MONEY BACK GUARANTEE

FOR WOOD SURFACES:

Kits include:

- Primer
- Finish
- Weekly Slip NoMor Cleaner
- Applicator: 2 covers

SIZES/PRICES**:

- 500 sq. ft. - \$325.
- 1,000 sq. ft. - \$528.
- 1,500 sq. ft. - \$760.
- 2,000 sq. ft. - \$1,000.

MONEY BACK GUARANTEE

**Appropriate quantities and materials are shipped base on size.

All prices include shipping & handling in the Continental U.S.A. For shipping outside of the Continental U.S.A., please contact an Aeson representative.

Prices do not include shipping and handling. For shipping & handling quotes, please contact a Aeson representative.

Beyond Maintenance

SLIP NOMOR COLOR

Renovate a floor without replacing it. Slip NoMor Color is a floor finish that can change the color, design, and look of any existing floor.

- Refresh existing color
- Hide stains and marks with color
- Introduce a new color
- Match logo design or school colors

Available in 10 basic colors and over 200 special order colors, Slip NoMor Color can help design a logo, form a pattern or change the color of the entire floor. The possibilities are limitless.

All Slip NoMor Systems are eco-friendly, easy to apply, and last up to two years. In extreme wear situations, it is recommended to re-apply every year.

No other finish does as much and lasts as long.

Call a Aeson consultant for price quote on color, design, and/or logo required.

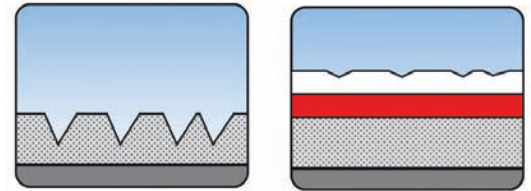

Heavy use and wear, together with dirt particles can cause permanent damage to the surface structure.

With Slipnomor Color System a brand new design can be put in place with excellent long term protection



CAUTION: SENSITIVE TO COLD WEATHER

All Slip NoMor products are sensitive to cold. Store at room temperature to prevent failure.

*Slip NoMor Finish has a shelf life of 9 months.

If you experience any problem with a Aeson product, you must notify Aeson within 72 hours of receipt to validate, exchange, or credit.

• 1000 sq ft Kit*

(Kit Contains: 1-Color finish, 2-Clear finish, 1-Slip NoMor Cleaner, 1-Slip NoMor Stripper, and Application tool)

Red - \$967. Yellow - \$902. Green - \$902. Orange - \$849.
Blue - \$928. Black - \$872. White, Lt., Med, and Dk Grey - \$814.

• 2000 sq ft Kit*

(Kit Contains: 2-Color finish, 4-Clear finish, 1-Slip NoMor Cleaner, 2-Slip NoMor Stripper, and Application tool)

Red - \$1442. Yellow - \$1376. Green - \$1377. Orange - \$1324.
Blue - \$1403. Black - \$1347. White, Lt., Med, and Dk Grey - \$1324.

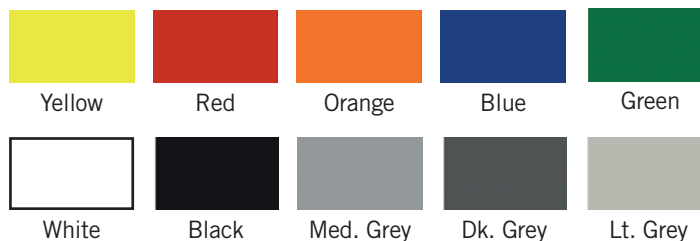

All prices include shipping & handling in the Continental U.S.A. For shipping outside of the Continental U.S.A., please contact an Aeson representative.

Beyond Maintenance

SLIP NOMOR SAFETY SYSTEM

By using a special additive with our Slip NoMor Maintenance Kit, you can turn any floor surface into a safety floor.

- Works on virtually any solid surface
- Increases coefficient of friction to American Disability Act levels
- Can be used in entrance areas, hallways, and anywhere slip and fall is an issue
- Maintains characteristics even in a wet environment
- Environmentally friendly
- Recycled product
- Not for use on sport surfaces
- Additive must be combined with Slip NoMor Finish or Slip NoMor Color Finishes

Easy and safe: SLIP NOMOR SAFETY

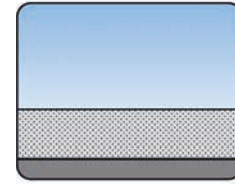

Smooth surfaces without Slip NoMor Safety

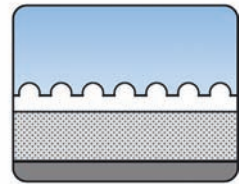

Slip NoMor ensures a nonslip surface structure and fulfills the strict health & safety requirements of the ADA.



SLIP NOMOR SAFETY SYSTEM

Includes Maintenance Kit and Additive.

COVERAGE	PRICE
500 sq. ft.....	\$355.
1000 sq. ft.....	\$558.
1500 sq. ft.....	\$815.
2000 sq. ft.....	\$1060.

Available in Matte (LM), Satin (S), High Gloss (HG)
Not recommended for use on sport floor surfaces.

SLIP NOMOR COLOR SAFETY SYSTEM*

Includes Maintenance Kit, Color, and Additive.

COVERAGE	PRICE
1000 sq. ft....	Kits individually priced based on color.* Add \$30. for Slip NoMor Color Safety System.
2000 sq. ft....	Kits individually priced based on color.* Add \$60. for Slip NoMor Color Safety System.

*See pg. 24 for pricing on color finishes

Shipping & Ordering Information

U.S. Headquarters

4701 Bath Street
#46 Philadelphia, PA 19137
215-636-9000
267-672-2912 (fax)
Email: info@aesonflooring.com

Canada

800-523-0960
(Toll free in the U.S. & Canada)
215-636-9000

International Orders

Please contact Aeson's Headquarters directly.

ON-LINE UPDATES

Check www.aesonflooring.com for availability, prices changes, special sales, new products, and answers to your flooring questions.

AESON E-NEWS

Receive the latest news, tips, and special offers. Simply sign up at www.aesonflooring.com!

FINANCING YOUR NEW FLOOR

For Only \$100. Down and \$100. Per Month!

Aeson announces its "\$100.00 Down/\$100.00 per month" finance program in conjunction with **Allstate Capital**. Well-qualified applicants can secure flooring without a considerable upfront capital investment and at the same time sustain a positive cash flow.

Applications are available online at www.aesonflooring.com or contact Allstate Capital directly at 800-949-0018 or www.allstatecapital.com.

Certain restrictions apply.

HOT RUSH DELIVERY SERVICE

When you have little or no time between ordering your floor and that studio opening or upcoming performance... rely on the Aeson Hot Rush Delivery Service. First, we ship your floor within 24 hours of receipt (in stock product only). We hot rush your order via truck. We call you with all the details of the shipment and an estimated time of arrival. We monitor the trucking company to make sure they expedite your order. There is a 10% surcharge for this service. Your Aeson sales representative will assist you. Expedited shipping is also available at an extra charge.



Aeson "eco friendly" products fit one or more of the following:

- Recyclable
- Reusable
- Made from recycled post consumer materials
- Made from renewable sources
- Made from managed forests
- Packaged in recyclable containers
- Made from recoverable waste materials
- No VOC's

IMPORTANT POLICIES

- If you experience any problem with a Aeson product, you must notify Aeson within 72 hours of receipt to validate, exchange, credit, or file insurance claim.
- Aeson will provide you with the computer tracking number, the shipping date, ETA, and trucking company.
- Free shipping of certain products means free ground shipping in the Continental U.S. only.
- You can select any trucking company or designate any appropriate means of pickup and transport. If you wish, Aeson will act on your behalf and will ship the "best way" unless otherwise instructed.
- Aeson is not responsible for costs related to the delay, damage, or installation of its flooring.
- Floors must be inspected for defects and dye-lot prior to installation.
- Installation of flooring denotes acceptance.
- Floors are shipped FOB our warehouse unless otherwise arranged via interstate trucking and fully insured in the customer's name. All claims must be made to the trucking company by the customer.
- Aeson cannot guarantee a date or time of delivery. We can and will give you our best estimate.

*All floor colors shown are for reference only. Please call for actual samples.
All information and pricing supersedes materials published prior to January 2011. All prices subject to change.*

Aeson now has warehouse facilities in Australia and Europe to expedite international orders.

Shipping & Ordering Information

TERMS AND AVAILABILITY

In stock- 2 days to three weeks delivery depending on destination. Special orders 3 to 8 weeks.

SHIPPING

Flooring will be shipped FOB Philadelphia or unless otherwise arranged.

All other products will be shipped prepaid UPS or FedEx unless shipped with flooring via interstate trucking. All freight prepaid or C.O.D.

Please note that truckers are not obliged to make inside deliveries. It is your responsibility to transport flooring from truck into your facility.

For shipments outside the continental U.S., orders ship via UPS International or Federal Express. Please call for rate.

Aeson is not responsible for delays in shipping once product has left our warehouse.

Flooring is shipped via interstate trucking. Cost is determined by weight and distance. Aeson will be happy to quote shipping costs. We discount all published rates.

To order floorcare products or tape, call **800-523-0960**, 24 hours a day to order with your credit card information. (USA only.)

PAYMENT

Purchase orders accepted from city, state, and federal institutions and public school systems. Net 30 days. All other orders must be prepaid. We accept **credit cards** (MasterCard, Visa, Discover, and American Express), **certified checks**, and **money orders** for U.S. and Canadian currency. Checks can now be faxed as payment to expedite your order. We can also provide current exchange rate for foreign currency.



All claims must be made to the trucking company by the customer.

HOW TO ORDER

PHONE

TOLL FREE ORDERING OR CUSTOMER SERVICE
800-523-0960 (Toll free in the U.S. & Canada)
215-636-9000

MAIL

Send your order to:

AESON
4701 Bath Street, #46 B
Philadelphia, PA 19137

Make checks payable to AESON FLOORING

FAX

267-672-2912

For credit card and check orders. Also for requests for information or price quotes.

E-MAIL

info@aesonflooring.com

For orders by credit card only. Also for requests for information or price quotes.

Visit our **WEBSITE** for the latest information on products, pricing and availability. **www.aesonflooring.com**

aeson
FLOORING SYSTEMS
Leading The Way In Sports & Fitness Flooring

**PERMANENT AND
PORTABLE FLOORING**

**FLOATING WOOD
SUBFLOOR SYSTEMS**

**MAINTENANCE AND
INSTALLATION PRODUCTS**

800-523-0960

(Toll free in the U.S. & Canada)

215-636-9000

**www.aesonflooring.com
info@aesonflooring.com**

This guide supercedes all previous pricing and technical information as of January 2011.

Prices and discounts are in USD and are subject to change without notice. For other currencies, please visit www.aesonflooring.com or call 800-523-0960 (Toll free in the U.S. & Canada).