

# FLOORING SURFACES SPRINGSTEP IV

For Architects,  
Specifiers and  
General Contractors

## Special Features

- Do-it-yourself in hours instead of days
- Transportable
- Includes the wood and shock absorption layer
- No hardware, screws, patching or sanding
- Snap together patented tongue and groove construction

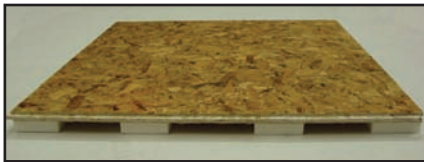

Springstep IV panel

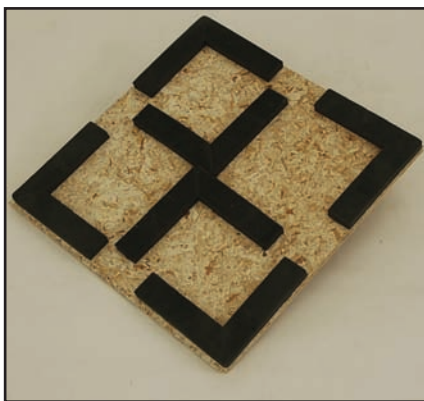

View from bottom of Springstep IV panel



"Eco-friendly" products meet one or more of the following criteria: recyclable, reusable, made from recycled post consumer materials, made from renewable sources, made from managed forests, packaged in recyclable containers, made from recoverable waste materials or have no VOC's.

The professional standard for floating wood resilient permanent and semi-permanent subfloors over concrete slabs and other hard surfaces. Resilient and energy absorbent. Safety and performance at a great price.

## SPRINGSTEP IV

The easy subfloor. The nominal 2' x 2' pre-fabricated Random Wafer Board panels, with patented tongue and groove connection system, rest on "L" shaped high density foam suspension forms. Springstep IV offers excellent energy absorption and resilience. Panels are sealed for water resistance. Its tongue and groove system allows for easy assembly.

The lightweight, 6.5 lb panels can be installed in hours instead of days. No screws. No staples. No nails. No patching. No sanding. It is 1/3 the work with no tools required.\*

Easy to disassemble, move to a new location and re-install.

\* Circular saw may be needed for custom fit.

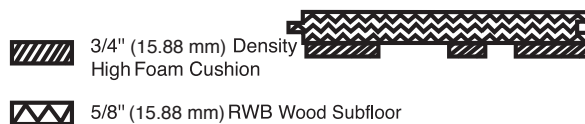
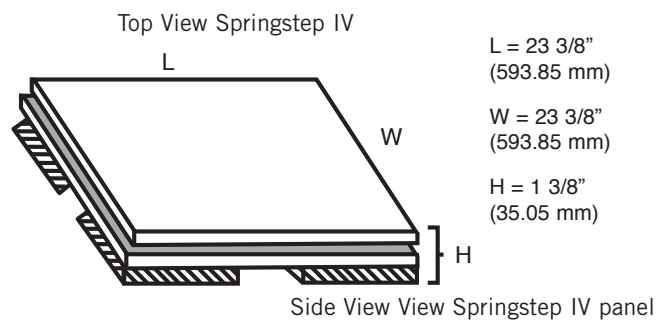

OVERALL HEIGHT 1 3/8" inches (35.05mm)

# FLOORING SURFACES SPRINGSTEP IV

	WOOD PANEL SIZE	UNDERLAYMENT
SPRINGSTEP IV	23 3/8" x 23 3/8" x 5/8" (593.85 mm x 593.85 mm x 15.88 mm) wood panels	3/4" (19 .05 mm) thick "L" shaped foam forms
SPRINGSTEP IV-A	23 3/8" x 23 3/8" x 5/8" (593.85 mm x 593.85 mm x 15.88 mm) wood panels	1/2" (12.70 mm) foam sheeting
SPRINGSTEP IV-B	23 3/8" x 23 3/8" x 5/8" (593.85 mm x 593.85 mm x 15.88 mm) wood panels	2" x 2" x 2" (50.80 mm x 50.80 mm x 50.80 mm) foam cubes
SPRINGSTEP IV-C	23 3/8" x 23 3/8" x 5/8" (593.85 mm x 93.85 mm x 15.88 mm) wood panels	3" x 3" x 3/4" foam blocks (peel & stick)

## INDIVIDUAL COMPONENTS

- 23 3/8" x 23 3/8" x 5/8"  
(593.85 mm x 593.85 mm x 15.88 mm)  
Springstep IV wood panels without foam
- 3/4" (19.05 mm) thick "L" shaped foam  
forms not sold separately
- 1/2" (12.70 mm) foam sheeting  
(5' wide by your custom length)
- 2" x 2" x 2" (50.80 mm x 50.80 mm x  
50.80 mm) foam cubes
- 2" x 2" x 2" (50.80 mm x 50.80 mm x  
50.80 mm) peel & stick foam cubes
- 3" x 3" x 3/4" (thick) peel & stick foam  
blocks

\* Minimum order 500 blocks/cubes for free shipping.

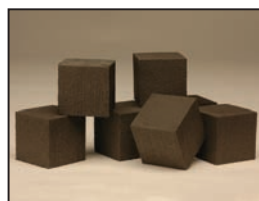

2" x 2" x 2"  
Foam Cube



3" x 3" x 3/4"  
Foam Block

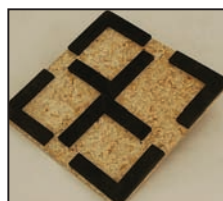

Springstep IV  
L-Shape Foam Layout

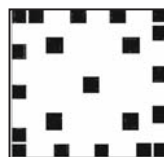

Springstep IV  
Foam Cube Layout  
2" x 2" x 2"  
(21 required)

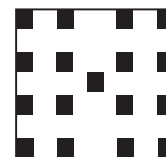

Springstep IV  
Foam Block Layout  
3" x 3" x 3/4"  
(17 required)



## TRANSITION PIECES (Ramps)

These new lightweight, poly-resin transition pieces are fully portable and easy to install. They can be placed and relocated without the use of permanent fasteners. The black, non-marring, anti-slip ramp is ADA compliant. With its all-new construction, these transition pieces can be easily trimmed to fit virtually any space with simple hand tools yet strong enough to support more than 1,000 pounds.

### Standard Configuration:

36" wide x 1.5" high x 8" slope  
Custom sizing available.

Information on this specification sheet supersedes all materials published prior to April 2011.